

Accessories (for DGB series)

DZ51 (Relay adapter) For connections of DG-B, DL-BR, DL-B and DT12/32NP* to LG, LH and LY displays

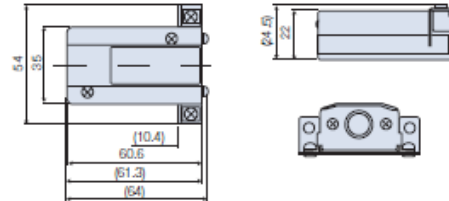

*To connect the DT12/32NP, use the DZ51 in combination with the MT10 detector.



Unit : mm

DZ-501 Digital gauging stand (for DG10B to DG100B, DE-30BR)



- Surface plate material: alumina ceramic
- Surface plate flatness: 2 μ m
- Surface plate size: 110 mm (4.33") x 110 mm (4.33")
- Maximum workpiece height: approx. 190 mm(7.48")
- Gauge mounting hole: ϕ 20mm (0.79")
- Mass: 13kg (28.67 lbs)

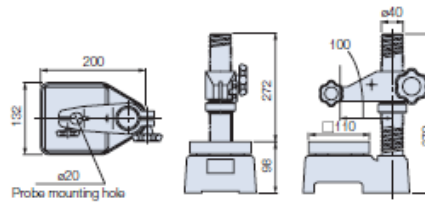

Unit : mm

DZ174-010/025/050 Air lifter (for DG10B to DG50B)

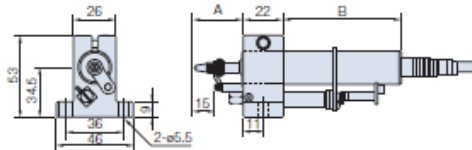

Measuring unit	A	B	Measuring unit	A	B
DG10BP/BN	32.5	75.5	DG25BS	47.5	98.5
DG10BS	32.5	56	DG25BL	47.5	98.5
DG25BP/BN	47.5	118	DG50BP/BN	72	200

Unit : mm

DZ-122 Feeler (for DG10B to DG50B)



- Contact point: ϕ 2.5 mm/0.098" carbide ball tip (mounting screw: M2.5 x 0.45)

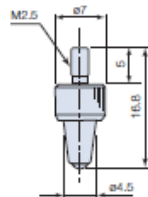

Unit : mm

DZ-100 Roller feeler (for DT Series, DG-B Series: except for DG155BP/205BP)

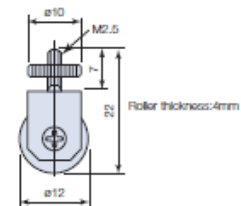

Unit : mm

DZ-181 Magnetic contact point feeler (for DG155BP/205BP)

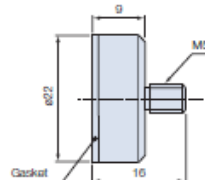

Unit : mm

DZ-191 Coupling

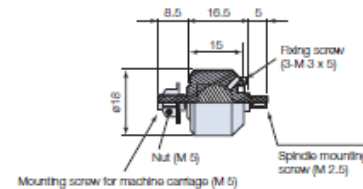

Unit : mm

DZ-801 Air lifter (for DG805BL/810BL)

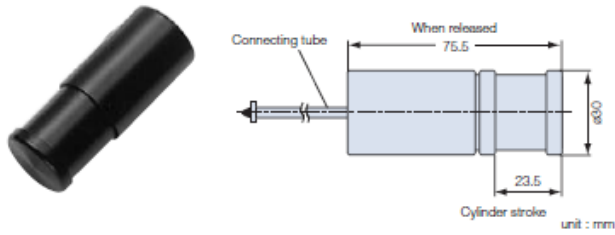

DZ-161 Lift lever (for DG-B except DG155BP/205BP; standard accessory for the DG110B)

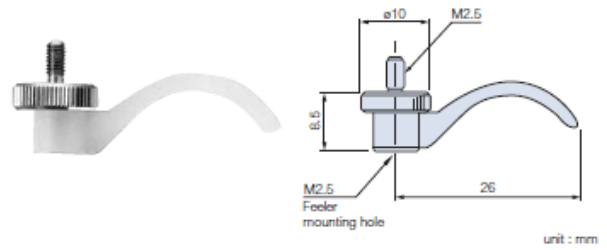

DZ-531 Digital gauging stand (for DK110, DG110B)

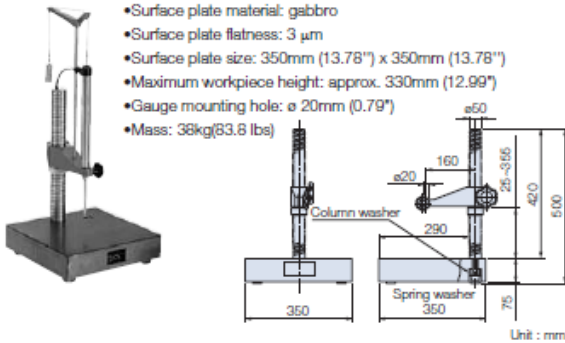

- Surface plate material: gabbro
- Surface plate flatness: 3 μm
- Surface plate size: 350mm (13.78") x 350mm (13.78")
- Maximum workpiece height: approx. 330mm (12.99")
- Gauge mounting hole: ø 20mm (0.79")
- Mass: 38kg(83.8 lbs)

DZ-581 Measuring force balancer (for DK110, DG110B)

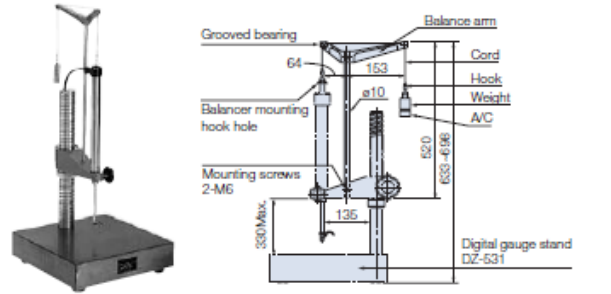

- Weight
- No weight: 1.55±0.15N(155±15gf)
 - B: 1.0±0.15N(100±15gf)
 - B+A: 0.7±0.15N(70±15gf)
 - B+C: 0.3±0.15N(30±15gf)

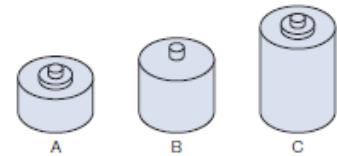

DZ-5100 Feeler set



•Plastic ball contact point: ø 3mm nylon ball

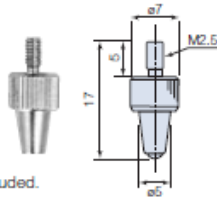

•Flat carbide contact point

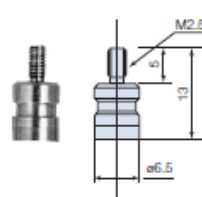

•Off-center contact point: ø 1mm steel ball

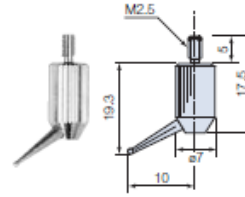

•Pin contact point

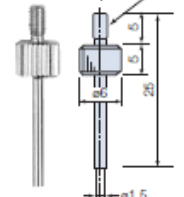

Note: The four contactors shown at right are included.

SZ70-1 Adapter

SZ70-1 is required for connecting the following scale units and counters:

Gauge unit : DE-BR Series, DG-B Series

Counter : LH71A/72, LY71 and LY72

* Adapter DZ51 is also required

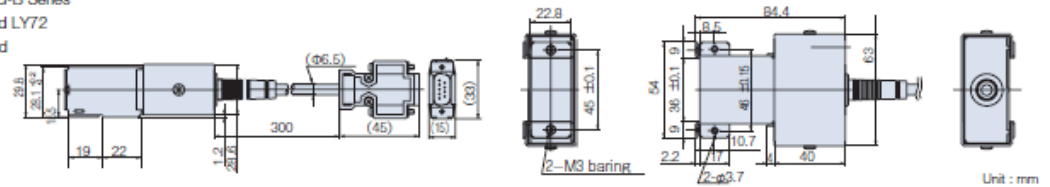

Connection Cables

Measuring unit	Adapter for LT series	LT series	Interface unit	Adapter for Counter	Connection cable	Counter unit	Interpolators	Extension cables
DK805A/B, DK806A/B, DK810A/B	-	LT30	MG (MG10-P1/P2) (MG20-DK) (MG30-B1/B2) (MG41-NC/NE) (MG42-4) Link Cable MZ41-**	-	CE-29-*** ***=-003(0.3m) -01(1m) -05(5m) -10(10m)	LY71, 72	-	CE-08** **=-01(1m), -03(3m), -05(5m), -10(10m), -15(15m)
DK10/25								CE-22** (Open-end) **=-01(1m), -03(3m), -05(5m), -10(10m)
DK50/100								CK-T** (Realize for flexion)
DK155PR5/205PR5								CK-T12(1m), T13(3m), T14(5m), T15(10m)
DK110NLR5								
DT12N/P	-	LT10A	MG (MG10-P1/P2) (MG20-DT) (MG30-B1/B2)	-	MT13 + CE-29	LY71, 72	MT12(for LT20A), MT13(for LT30) MT14(Cable with unterminated)	CE-08** **=-01(1m), -03(3m), -05(5m), -10(10m), -15(15m)
DT32N/NV/P/PV								CK-T12(1m), T13(3m), T14(5m), T15(10m), CK-T10(1m) CK-T105(5m) (Realize for flexion)
DT512N/P		LT11A						-
DG805B/810B	-	LT20A	MG (MG10-P1/P2) (MG20-DG) (MG30-B1/B2)	-	-	LY71, LY72	MD10A/20B ※D-sub15pin Female	-
DG10B/25B								
DG50B/100B/155B/205B								
DG-110B								
DL-B	-	LT20A	MG (MG10-P1/P2) (MG20-DG) (MG30-B1/B2)	DZ51 + SZ70-1	-	LY71, LY72	-	-
DE-BR	SZ70-2	LT30	SZ70-2+ MG (MG10-P1/P2) (MG20-DG) (MG30-B1/B2)	SZ70-1	-	LY71, LY72	-	-

Compatible

Measuring unit	Adapter for LT series	LT series	Adapter for Counter	Connection cable	Counter unit	Interpolators	Extension cables
DT32N/NV/P/PV	Interpolator MT12 LZ60-P1/P2 is required to connect to LT100.	LT20 LT100	MT12 + DZ51	—	LY51, LY52	—	CE-08** **=-01(1m), -03(3m), -05(5m), -10(10m), -15(15m)
DT512NP							
DT12NP							
DT32N/NV/P/PV	—	LT10					CK-T12(1m), T13(3m), T14(5m), T15(10m) T101(3m) T105(5m) (Realize for flexion)
DT512NP							
DG805B/810B	—	LT11					
DG10B/25B	—	LT20 LT100	DZ51	—	LY51, LY52	—	—
DG50B/100B/155B/205B							
DG110B							
DL-B	—	LT20 LT100	DZ51	—	LY51, LY52	—	—

A description of external form chart of the screw

- When a screw thread is not mentioned in the Dimensions,
It is mean numerical value base on standard pitch (National Coarse).
- The screw which conformed to ISO and JIS is enclosed.