

Magnescale®

Digital Tolerance Indicator

MF10-P1/MF10-P2

Read all the instructions in the manual carefully before use and strictly follow them. Keep the manual for future references.

Instruction Manual

PRECAUTIONS ON SAFETY

● Meanings of Signal Words

CAUTION Indicates a potentially hazardous situation which, if not avoided, may result in minor or moderate injury or in property damage.

● Warning Indications

PRECAUTIONS

Do not use the product with voltage in excess of the rated voltage. Excess voltage may result in malfunction or fire.

Never use the product with an AC power supply. Otherwise, explosion may result.

PRECAUTIONS FOR SAFE USE

The following precautions must be observed to ensure safe operation of the product. Doing so may cause damage or fire.

■ Installation Environment

- Do not use the product in environments subject to flammable or explosive gases.
- To secure the safety of operation and maintenance, do not install the product close to high-voltage devices and power devices.
- Do not use the product in any atmosphere or environment that exceeds the ratings.
- Do not use the product in environments subject to exposure to water, oil, chemicals, etc.

■ Power Supply and Wiring

- Do not impose voltage exceeding the rated voltage: 10 to 30 VDC, including 10% ripple (p-p).
- Do not apply voltages or currents that exceed the rated ranges.
- When supplying power to the product, make sure that the polarity of the power is correct, and do not connect to an AC power supply.
- Do not miswire such as the polarity of the power supply.
- Do not apply any load exceeding the ratings.
- Connect the load correctly.
- Do not short both ends of the load.
- Do not short-circuit the open collector output load.
- Be sure to turn OFF the power when you plug/unplug the connector with the measuring unit, connect/disconnect with the digital tolerance indicator, or add digital tolerance indicators.
- High-Voltage lines and power lines must be wired separately from this product. Wiring them together or placing them in the same duct may cause induction, resulting in malfunction or damage.

■ Installation

- Do not install the product in locations subjected to strong magnetic field or electric field.
- Others
 - Do not attempt to disassemble, repair, or modify the product in any way.
 - Do not use the product if the case is damaged.
 - When disposing of the product, treat it as industrial waste.
 - When making setting, be sure to check safety such as by stopping the equipment.

PRECAUTIONS FOR CORRECT USE

■ Installation Location

- Do not install the product in the following locations.
 - Locations subject to direct sunlight
 - Locations subject to condensation due to high humidity
 - Locations subject to corrosive gas
 - Locations subject to vibration or mechanical shocks exceeding the rated values
 - Place where there are dusts, salt contents or iron powders

■ Power Supply and Wiring

- It may take time for the measurement to stabilize right after the power is turned ON, depending on the environment.
- Output pulses may occur when the power supply is turned OFF. Turn OFF the power supply to the load or load line first.
- The product is ready to operate 1.5s after the power supply is turned ON. If the digital tolerance indicator and load are connected to power supplies separately, turn ON the power supply to the product first.
- Be sure to turn OFF the power when you plug/unplug the connector with the measuring unit, connect/disconnect with the digital tolerance indicator, or add digital tolerance indicator.
- Extended length on the digital tolerance indicator end must be up to 30 m. For extension, use a cable with 0.3 mm² larger.

■ Installation

- Do not apply the forces on the cord exceeding the following limits: Pull: 40 N; torque: 0.1 N·m; pressure: 20 N; bending: 3 kg
- Do not pull or twist the measuring unit connector with excessive force when it is fixed to the digital tolerance indicator. (9.8 N or less)

■ Others

- Always keep the protective cover in place when using the product. Not doing so may cause malfunction.
- Do not use thinner, benzene, acetone, and lamp oil for cleaning.

Checking the Package Content

- Digital tolerance indicator: 1
- Instruction Sheet (this sheet)

[For U.S.A. and Canada]

THIS CLASS A DIGITAL DEVICE COMPLIES WITH PART15 OF THE FCC RULES AND THE CANADIAN ICES-003. OPERATION IS SUBJECT TO THE FOLLOWING TWO CONDITIONS.

- (1) THIS DEVICE MAY NOT CAUSE HARMFUL INTERFERENCE, AND
- (2) THIS DEVICE MUST ACCEPT ANY INTERFERENCE RECEIVED, INCLUDING INTERFERENCE THAT MAY CAUSE UNDERSIGNED OPERATION.

CET APPAREIL NUMÉRIQUE DE LA CLASSE A EST CONFORME À LA NORME NMB-003 DU CANADA.

1 Installation

1-1 Dimensions

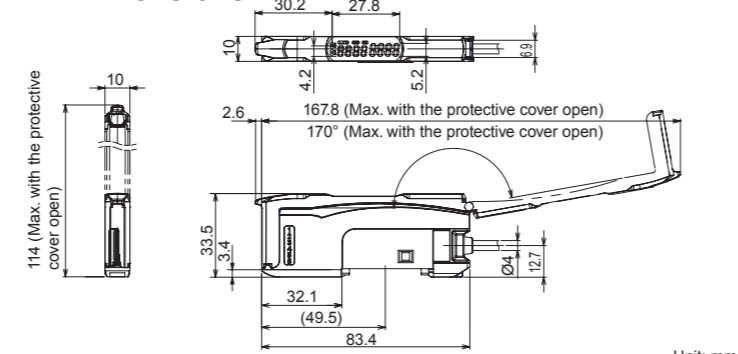

※ Dimensions in parentheses () indicates the ones with related components. The cover could come off if it is tilted by 170 degrees or more.

Unit: mm

1-2 Input/Output Circuit Diagram

■ MF10-P1 (NPN type)

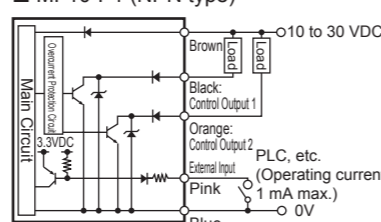

■ MF10-P2 (PNP type)

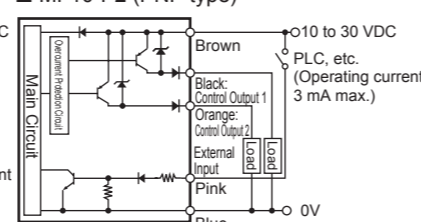

1-3 Mounting the Digital Tolerance Indicator

■ Mounting on DIN Track

- Let the hook on the digital tolerance indicator's measuring unit connection side catch the track.
- Push the unit until the hook clicks into place.

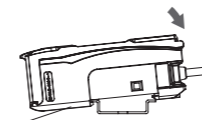

■ Removing from DIN Track

- Push the unit in the direction 1.
- Lift the unit in the direction of arrow 2 while performing step (1).

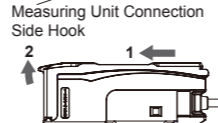

■ When used in a row

- Up to 30 digital tolerance indicators can be installed in a row.

* Fix the cable in a suitable position to prevent possible cable breakage.

1-4 Mounting the Measuring Unit

- Open the protection cover.
- Insert the measuring unit, with the lock lever on its connector area facing upward, all the way into the connector port.

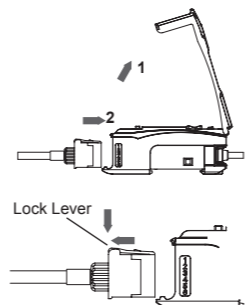

To remove it, press and hold the lock lever then pull the measuring unit out.

* Fix the cable in a suitable position to prevent possible cable breakage.

2 Settings

2-1 Setting and Display Overview

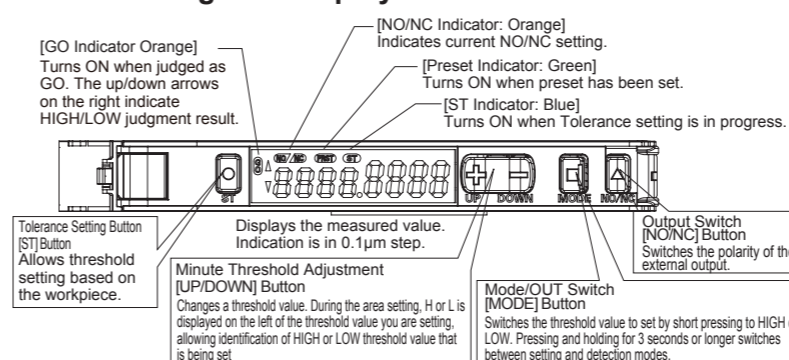

2-4 Tolerance Judgment

* Also see "5. Detailed Settings" when making the settings.

Setting for sensing within the range of the upper and lower limits (Threshold 2-point)

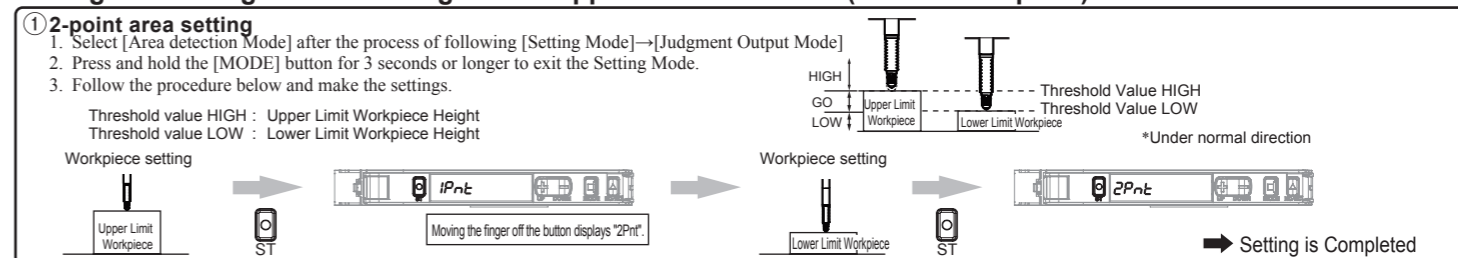

Measuring a workpiece with ± tolerance (Threshold 2-point)

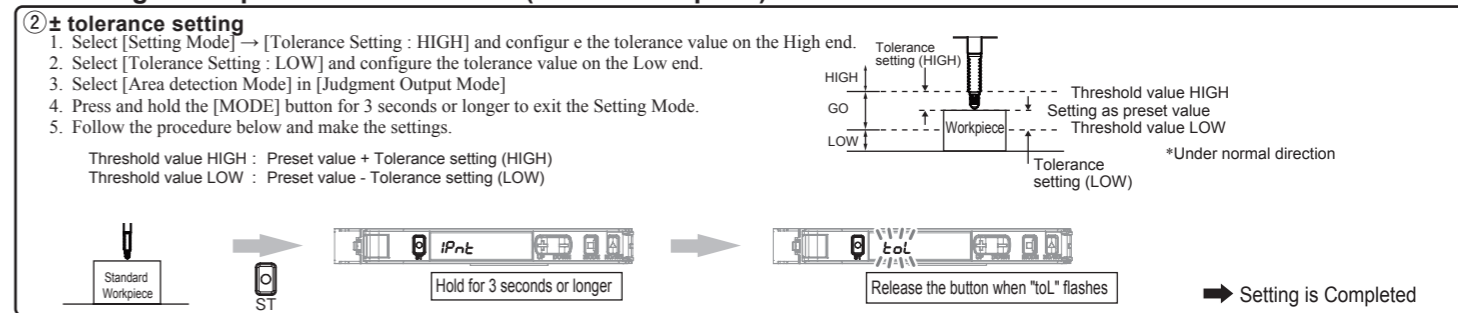

Measuring for one reference (Threshold 1-point)

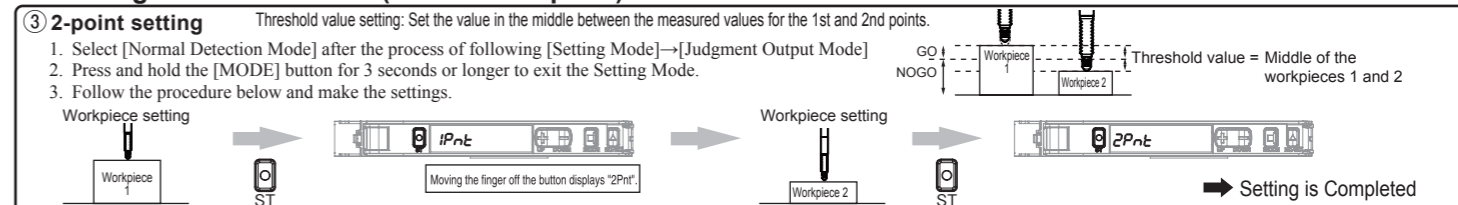

Measuring for standard workpiece as reference (Threshold 1-point)

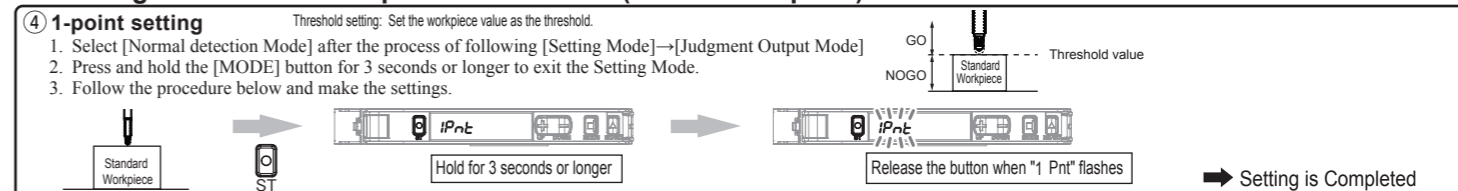

● Setting Error

Error / Display / Cause	Error Origin Tuning Type	Remedy
Tolerance Judgment Error Err Err	① ②	· Ensure the wider distance between the 1st and the 2nd measuring points. · Set the larger difference between the tolerance settings of HIGH and LOW. · For hysteresis setting, configure a smaller setting value.
Near Error nErr Err	③	· Configure the preset value again. · Configure the tolerance setting again. · For hysteresis setting, configure a smaller setting value.
Overflow Error ovEr FLoY	① ② ③ ④	· Configure the preset value again. · Configure the tolerance setting again.
Underflow Error Undr FLoY	① ② ③ ④	· Configure the preset value again. · Configure the tolerance setting again.

2-2 Switching Control Output

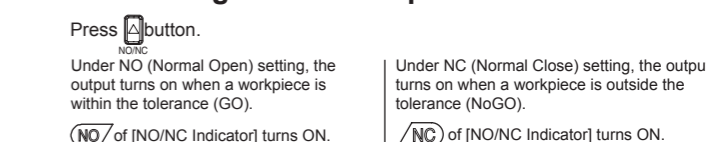

2-3 Reference Point

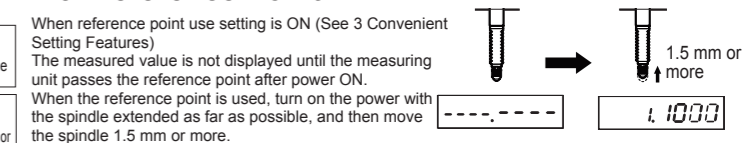

2-5 Minute Adjustment of Threshold Level

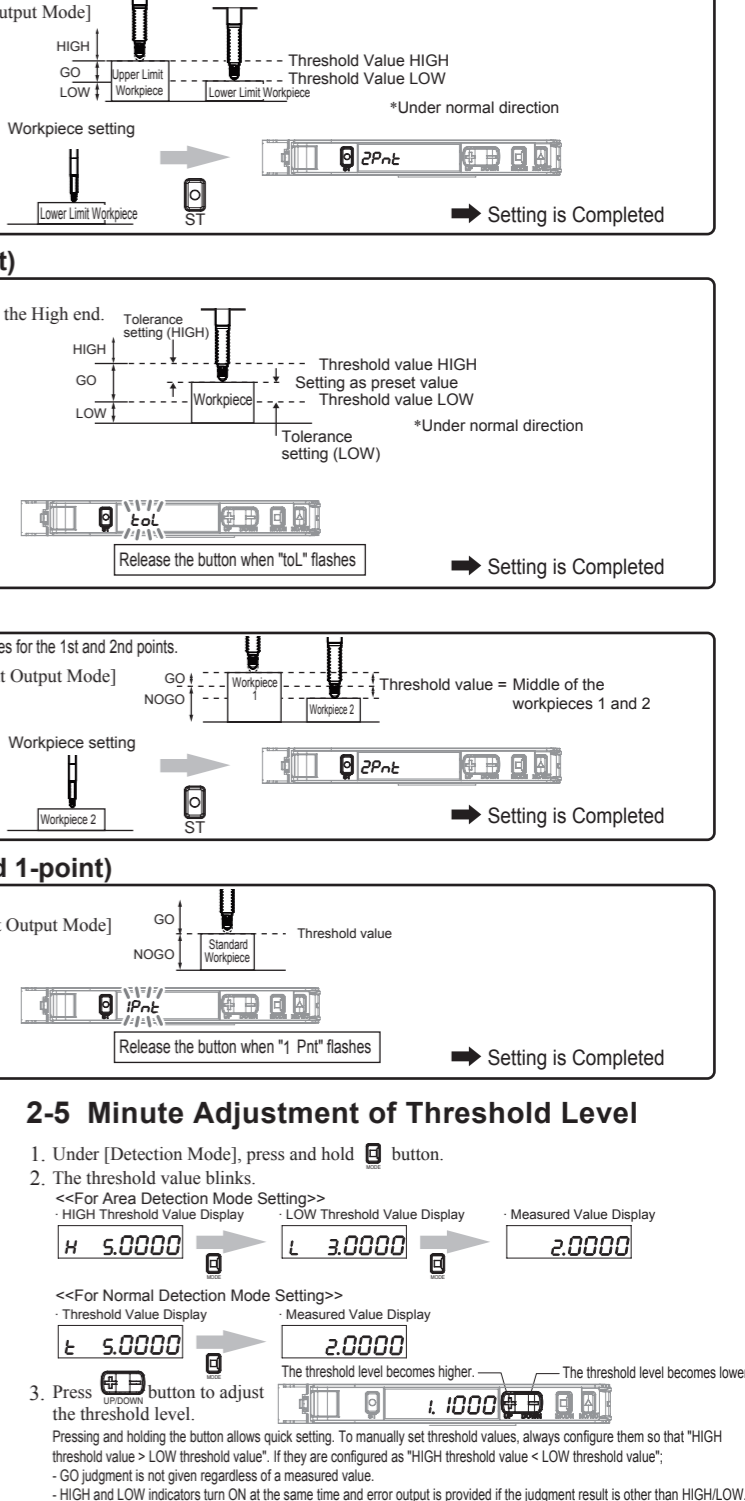

3 Convenient Setting Features

Initializing Settings

- **Setting Reset** Initialize all settings to the factory-set defaults.

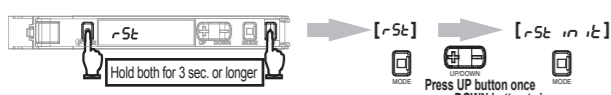

Saving/Reading Settings

- **User Save Function/User Reset Function**

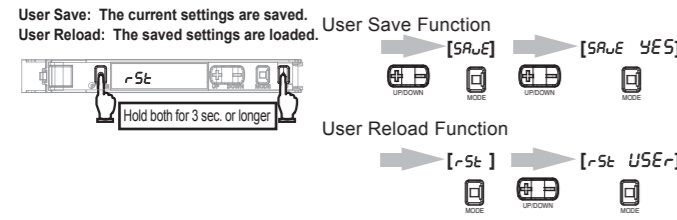

Using the measuring unit reference point/Setting the point at power ON as origin

- **Reference Point Use Setting**

1. Select [Setting Mode] → [Reference Point Use Setting].
ON : The unit automatically waits for the reference point signal. When the reference point is used, turn on the power with the spindle extended as far as possible, and then move the spindle 1.5 mm or more. A measured value is displayed.
OFF: The reference point is set as the position of the measuring unit at power ON, and the measured value is displayed.
The displayed value is the preset value.
- * After the setting, turning the power OFF then ON, or searching the reference point again, reflects the reference point use setting to measurement.
- * When the reference point use setting is ON, a hyphen mark (-) is displayed until the measuring unit passes the reference point.

Preventing Malfunction

- **Key Lock Function** Disables all the button operations.



- **Reference point search again** (to capture the measuring unit reference point again)

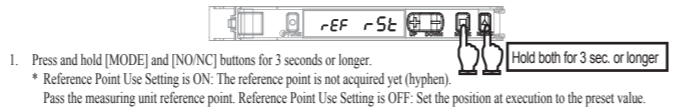

- **Preset Function**

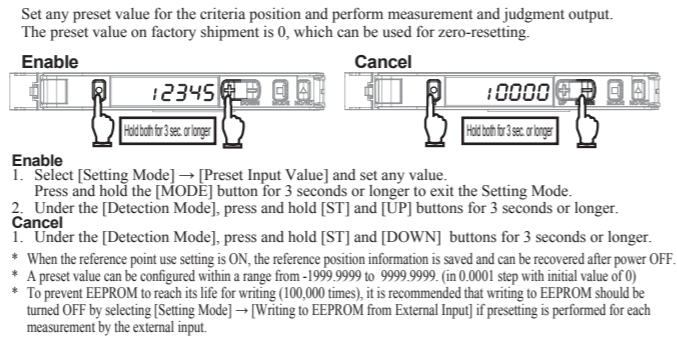

4 Maintenance

4-1 Troubleshooting

- **Troubleshooting**

Phenomena	Cause	Remedy
Nothing is shown on the indication.	Is the power supply ON? Are the cables not broken?	Check the wiring and measuring unit, the power supply voltage and capacity. → Refer to "1-2 Input/Output Circuit Diagram".
The digital tolerance indicator restarts during operation.	Is the Eco Function not turned ON?	Turn OFF the Eco function. → Refer to "5 Detailed Settings".
Nothing is shown on the digital indication.	Are the external input settings OFF?	Check the wiring and external input settings. → Refer to "1-2 Input/Output Circuit Diagram".
The measured value is not displayed in 0.0001 step	Have the display digits configuration property?	Configure it properly. → Refer to "5 Detailed Settings".
The judgment output is not properly provided	Have the tolerance setting and hysteresis properly configured?	Configure the tolerance setting and hysteresis properly. → Refer to "5 Detailed Settings".
Lost tracking of the settings made.	-	Reset the settings. → Refer to "5 Detailed Settings".

- **Error Display**

Error Name / Display	Cause	Remedy
Load short circuit detection error E-St	The judgment output line is short circuited.	Turn off the power supply, check whether the output line is short circuited or not, and then turn on the power supply again.
Overcurrent protection error E-Hd CUR	A connection error is found in the measuring unit.	Check if the measuring unit is correctly mounted, and turn ON the power supply again.
Digital tolerance indicator EEPROM error E-nE 01	An error is found in the digital tolerance indicator setting memory.	Turn ON the power again. Reset the settings if the error is not corrected.
Measuring unit communications time-out error E-Hd Co n 1	A communications error is found between the measuring unit and the digital tolerance indicator.	Turn OFF the power supply and check if the measuring unit and digital tolerance indicator are correctly connected, and then turn ON the power supply again. If the error persists, the measuring unit or digital tolerance indicator is broken. Replace the measuring unit or digital tolerance indicator.
Measuring unit memory error E-Hd nE n 2	An error is found in measuring unit setting memory.	Turn OFF the power supply and check if the measuring unit is correctly connected, and then turn ON the power supply again. If the error persists, the measuring unit is broken. Replace the measuring unit.
Measuring unit speed error E-Hd SPD	The speed of passing the reference point was too high.	Check that excessive impact is not applied to the measuring unit. Turn ON the power supply again or perform the reference point research. → Refer to "3 Convenient Setting Features"
Measuring unit signal level error E-Hd Lu	A measuring unit circuit failure	Check if the measuring unit is correctly mounted, and then turn ON the power supply again. If the error persists, the measuring unit is broken. Replace the measuring unit.

- **Status Display**

Error Name / Display	Cause	Remedy
Lock ON LoC on	The key lock function enabled	Cancel the key lock function. → Refer to "3 Convenient Setting Features"
Measured value upper limit error ouEr	The measured value is over the display upper limit (9999.9999).	Review the preset value.
Measured value lower limit error Lo	The measured value is under the display lower limit (-1999.9999).	Review the preset value.
Moving average count unreached ---	The measured values for the number of moving average count is being acquired from the measuring unit.	Please wait until the moving average result is calculated
Reference point not acquired ---	The measuring unit did not pass the reference point.	Have the measuring unit pass the reference point (the point the measuring unit is pressed in by 1.5 mm or more from where it is fully extended).

4-2 Ratings and Specifications

Model	NPN output	MF10-P1
	PNP output	MF10-P2
Control output	2	
External input*4	1	
Minimum display unit	0.1 μm	
Power supply voltage	10 to 30 VDC, including ripple (p-p) 10%	
Power consumption*1	Power supply voltage 24 V: Normal mode: 2040 mW max. (Power consumption 85 mA max.) Power saving ECO: 1920 mW max. (Power consumption 80 mA max.)	
Control output*2	Load voltage: 30 VDC max., open collector output type Load voltage: The total of the two outputs must be 100 mA max. (Residual voltage and load current less than 10 mA: 1 V max.) Load current 10 to 100 mA: 2 V max. Off state current: 0.1 mA max.	
Protection circuit	Power supply reverse polarity protection, output short-circuit protection and output incorrect connection protection	
Number of banks	4	
Ambient temperature range*3	Operating: When lining up 1 or 2 digital tolerance indicators: 0°C to 55°C Storage: -10°C to 60°C (with no icing or condensation)	
Ambient humidity range	Operating and storage: 35% to 85% RH (with no condensation)	
Mass	Approx. 75 g	
Cable lengs	2 m	

1. Power supply voltage 10 V to 30 V:
Normal mode: 2250 mW max. (Power supply voltage 30 V: Power consumption 75 mA max./Power supply voltage 10 V: Power consumption 155 mA max.)
Power saving ECO: 2100 mW max. (Power supply voltage 30 V: Power consumption 70 mA max./Power supply voltage 10 V: Power consumption 135 mA max.)
2. When lining up 4 or more digital tolerance indicators, the 2 output total is 20 mA or less.
3. When used in a row, operating ambient humidity ranges are:
3 to 10: 0°C to +50°C, 11 to 16: 0°C to +45°C, 17 to 30: 0°C to +40°C
4. Details on inputs are as follows:

	Contact input (Relay or switch)	Non-contact input (Transistor)	Input time
NPN output	ON: Short circuit to 0 V (Outflow current: 1 mA max.) OFF: Open or short circuit to Vcc	ON: 1.5 V max. (Outflow current: 1 mA max.) OFF: Vcc-1.5 V to Vcc (Leakage current: 0.1 mA max.)	ON: 2 ms min. OFF: 20 ms min.
PNP output	ON: Short circuit to Vcc (Sink current: 3 mA max.) OFF: Open or short circuit to 0 V	ON: Vcc-1.5 V to Vcc (Sink current: 3 mA max.) OFF: 1.5 V max. (Leakage current: 0.1 mA max.)	

5 Detailed Settings

Hold **MODE** button for 3 seconds or longer to enter Setting mode.

Setting mode provides the function settings described hereafter. The initial display shown after transition from one function to another represents the factory default.

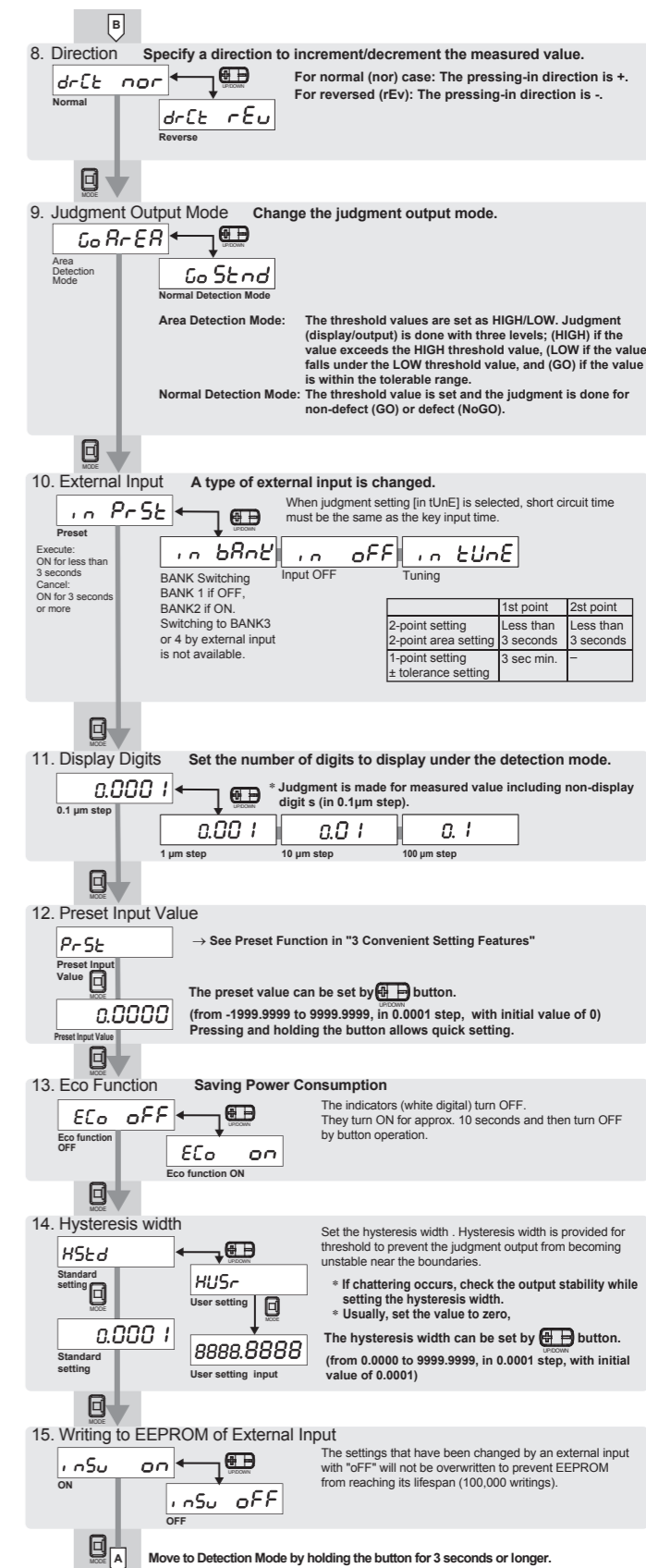
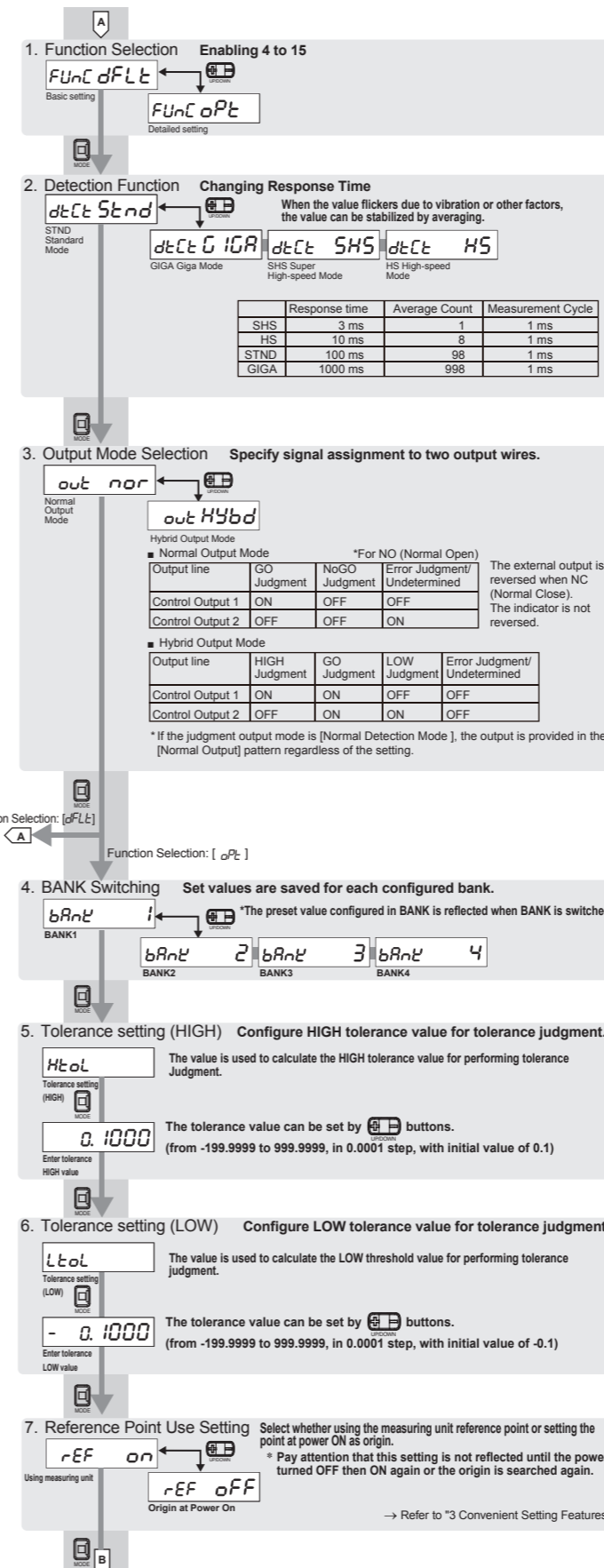

Note) After finish the setting, if the measuring unit which measuring length differs is re-connected, the setting value will be initialized.

Magnescale Co., Ltd.

Shinagawa Intercity Tower A-18F, 2-15-1, Konan, Minato-ku, Tokyo 108-6018, Japan

MF10-P1/MF10-P2
2-A01-184-1A

2013.3
Printed in Japan
©2013 Magnescale Co., Ltd.